

Cabinet Mount Lifter Instructions

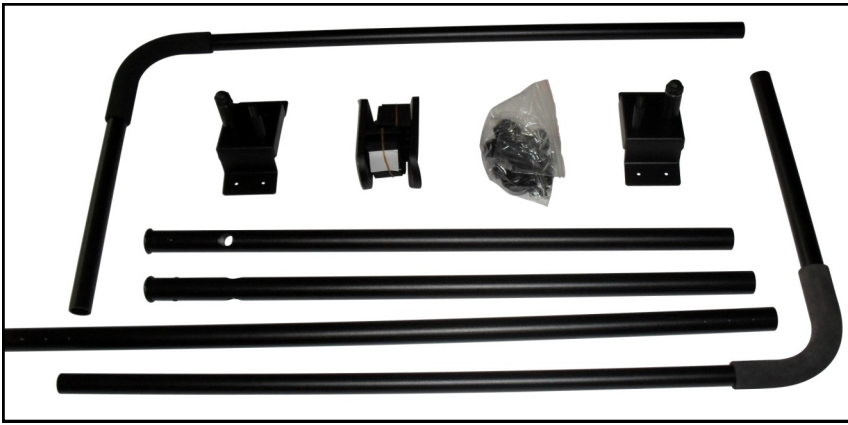

PART LIST

 2 @ Side Pivot Arms	 1 @ Coupler Tube
 1 @ Left Hand Bracket	 1 @ Right Hand Bracket
 2 @ Cover Support Arms w/ Foam Grip	 1 set of Cover Saver
 4 @ 4" Wood Screw	 8 @ 1" Wood Screw
 12 @ 1" Black Tek Screw	 2 @ 1/2" Lock Nut
 2 @ 3/4" Black PVC Cap	 24 @ Black PVC Push Cap
 2 @ 9/16" Washer	 4 @ 1/2" Washer
 1 @ 1/8" Drill Bit	 1 @ Phillips Driver
 4 @ 1/2" Black Saddle	

NOTE: THE ABOVE ARE ESSENTIAL COMPONENTS, HOWEVER WE DO ADD SOME EXTRA QUANTITIES OF SOME COMPONENTS AS WELL JUST FOR BACKUP.

Cabinet Mount Lifter Instructions

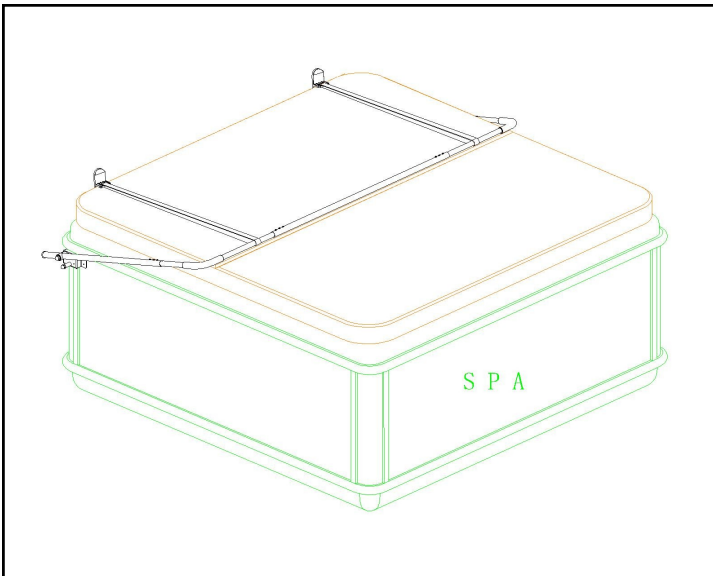

Make sure that you have all the parts from the parts list

Note: All left and right directions are from standing in front of Hot Tub

STEP 1:

The spa cover should be in the closed position, and make sure the cover is square on the spa.

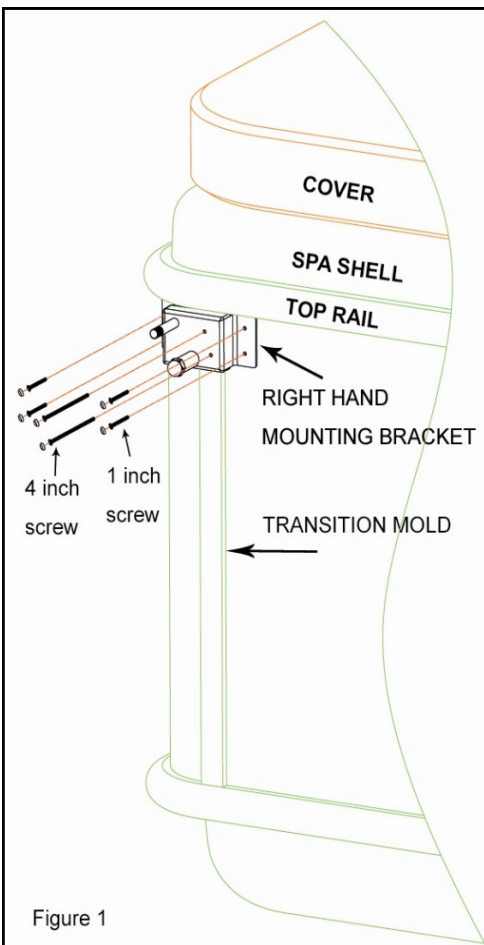

STEP 2:

Take brackets from lifter kit. Place against side of spa. The bent flange should sit flush with the underside of the top rail on cabinet. Back of bracket should be squared up to the transition mold on the corner of your cabinet.

Note: The bolt with two spacers attached to it must be higher than the other bolt. This, along with the bent flange. Determines which side of spa the bracket should be attached to. (Fig. 1)

STEP 3:

Holding the bracket in place. Pre-drill holes into your spa's cabinet using the holes already made in the bracket as a guide. Once holes have been drilled, mount bracket to cabinet using 4 one inch screws for front and back flanges and 2 four inch for center holes. (Fig. 1)

STEP 4:

Repeat steps 2 & 3 for opposite side. Brackets are now installed.

Cabinet Mount Lifter Instructions

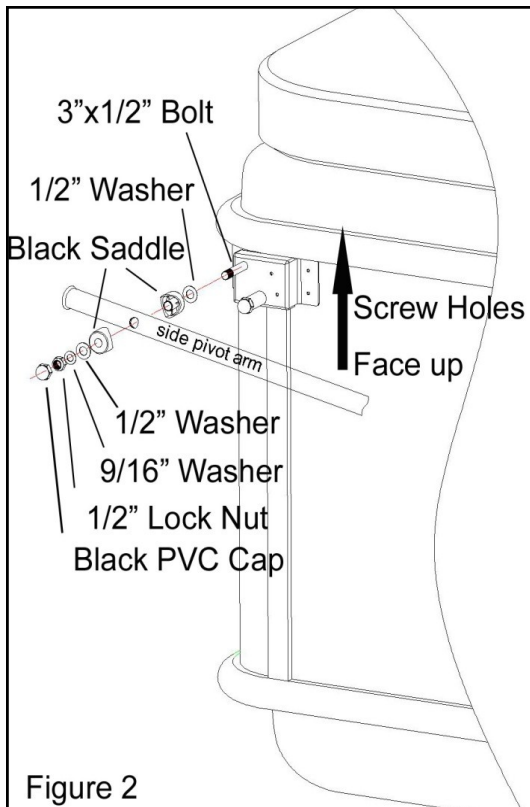

Figure 2

STEP 5:

From the wrapped up tubing in our lift kit, select the two short, straight bars (Pivot Arms). See Figure #2 for Pivot Arm Installation procedure. Leave loose for later installation ease. Note - Do NOT apply Black PVC Cap. Prepare other side of spa's pivot arm assembly.

STEP 6:

Center the straight arm on top of the spa's cover so it is on the outside edge of cover hinge towards mounted brackets. Also have pre-drilled holes on the straight arm positioned toward the back of the Spa to avoid future cover damage occurred by the screw heads. (Fig. 3 & Fig. 5)

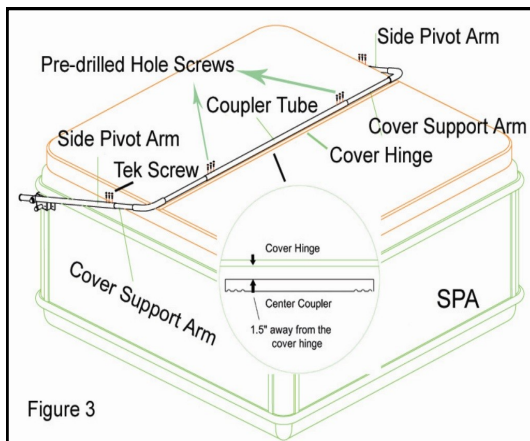

Figure 3

STEP 7:

Slide cover support arms into side pivot arms until it is aligned with the center coupler tube. Move the center coupler tube towards cover hinge. Allow side cover support arm to rest on spa cover. Slide the coupler tube over the straight arms until it is centered on cover. (Fig. 4)

NOTE: Confirm Coupler Tube is 1.5" from center of cover when installed as per COVER SAVER direction requirements. (Fig. 3)

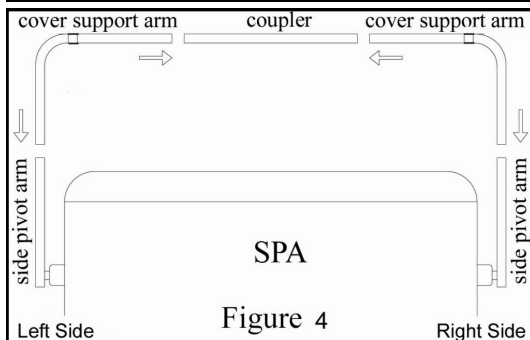

Figure 4

STEP 8:

Move to other side of spa cover. Slide cover support arm into side pivot arm. As you slide into the center straight arm, hold it in place to maintain center position on cover at the same time sliding pivot arm into 1/2" bolt on bracket (Fig. 2 & Fig. 4)

NOTE: Check step 6 to make sure everything is positioned correctly.

STEP 9:

Confirm again the cover is square on hot tub cabinet then tighten left and right Pivot Arm 1/2" nuts. Now install Black PVC Cap on nuts.

Cabinet Mount Lifter Instructions

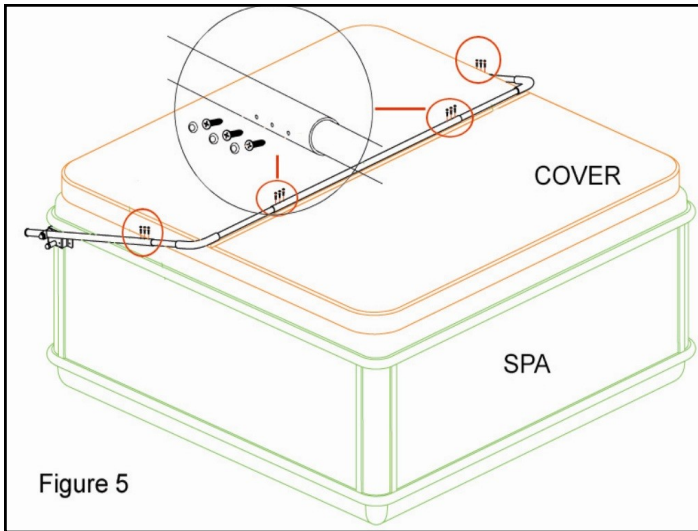

STEP 10:

Affix one Cover Support Arm with one Tek screw, now lift cover lifter into the raised position and confirm the left and right side Cover Support Arms are equal in height from the top of the cover. When equal distance or level affix one Tek screw in opposite side Cover Support Arm. (Fig. 3 & Fig. 4)

NOTE: Confirm that you CENTER the Coupler Tube on Left and Right Cover Support Arm, with screws facing to back of Hut Tub to prevent possible cover damage from screw heads. (Fig. 5)

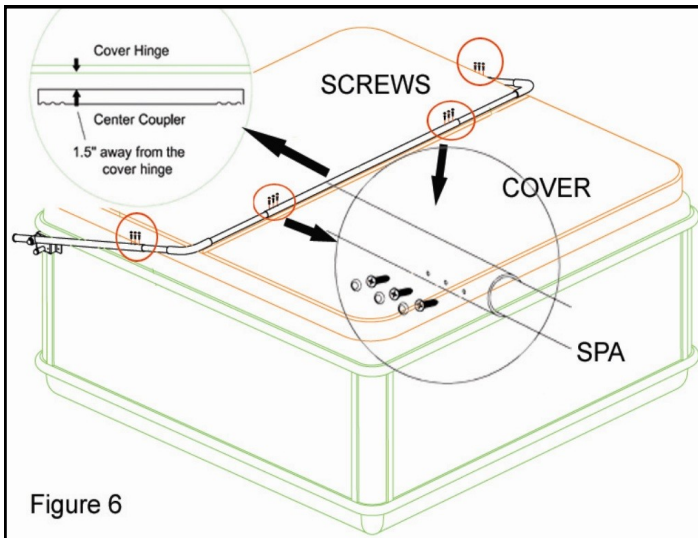

STEP 11:

Now install all remaining Tek Screws as per Figure #5.

STEP 12:

Install all Black PVC Caps over screw heads for esthetics.

STEP 13:

Your lifter is now installed. Install Cover Saver as per instructions included.

COVER SAVER INSTRUCTIONS

Prevent the possibility of damages caused by cover lifters to your spa cover seam.

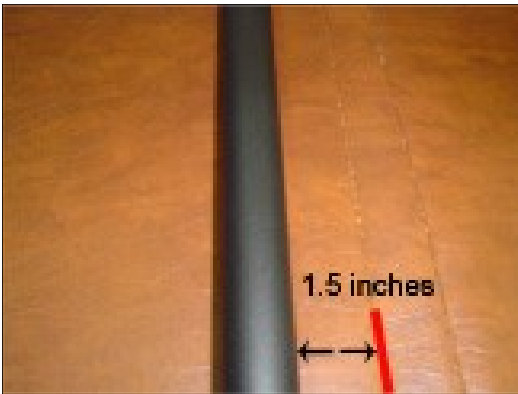

Step 1: Center the cover on the hot tub so it is even on all four sides. The center support bar has to be 1.5 inches from the center of the cover.

Note: When using Cover Saver with new or existing lifters, make sure the center is 1.5 inches away from the center. On existing lifters, you may have to adjust the side pivot arms by removing the screws to allow the cover support arms to move. (See Step 1)



Step 2: Place one piece of Velcro 1 1/2 inch from the inside edge of the cover handles on each side.

Note: There are two supports to be installed. To permanently apply Velcro, use silicon or Crazy Glue (not supplied).

Note: For Cover with pockets, please omit this step.

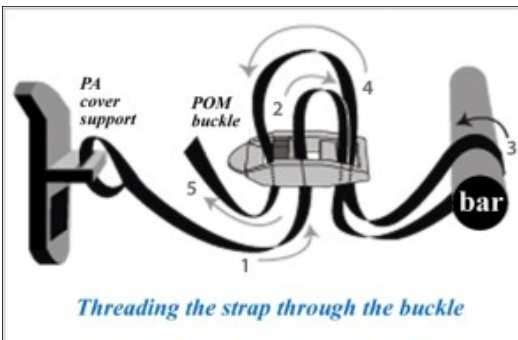

Step 3: Thread the strap through the buckle as shown. Repeat for the other strap.

Part List:

- 4 - 1 1/2" pieces adhesive Velcro
- 2 - PA cover supports, including 145mm PP straps
- 2 - 1 1/2" POM buckles

LET'S CHECK:



When Cover Lifter is in the upright position, the cover should not be resting on the center bar.

After installation, trim excess straps from buckles, melt ends so they do not fray.

All the weight of the cover should be resting on your Cover saver if your Cover Saver has been properly installed.

